





BLADES FOR MTD



WITH NEW "DIAMOND" CENTER HOLE

ORDER NO	Replaces O.E.M No.	Length	Center Hole Diam.	Width	Steel Thick	Application
REPLACES MTD						
15 - 17224 	MTD/CUB CADET 742-05094, 742-05094-X	17-1/4" 438.15mm	Diamond	2-1/4" 57.2mm	.158" 4.0mm	3 PCS PRO DEVICE SERIES XT1 LT50, XT3 QS127, XZ5 L127, XZ6 L127 AND ZT2 50 ULTIMA FROM 2022
15 - 17225 	MTD/CUB CADET 742-05086-X	18-5/8" 473.07mm	Diamond	2-1/4" 57.2mm	.158" 4.0mm	3 PCS PER DEVICE SERIES XT3 QS137, XZ5 L137 FROM 2022
15 - 17222 	MTD CUB CADET 742-5177A-X, 742P05177-L	21-3/16" 538.15mm	Diamond	2-1/4" 57.2mm	.158" 4.0mm	2 PCS PER DEVICE SERIES XT1, XT2, LT3, XZ5, XZ6 WITH 107 CM / 42" CUTTING WORK FROM 2022
15 - 17223 	MTD CUB CADET 742-05510, 742-05510-X, 742-05510-L	23-1/4" 590.55mm	Diamond	2-1/4" 57.2mm	.158" 4.0mm	2 PCS PER DEVICE SERIES XT2, XZ6 WITH 117 CM / 46" CUTTING WORK FROM 2022

"Blade Illustration shown Bottom View"

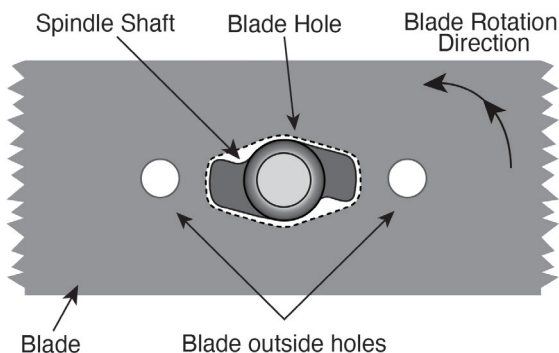

Illustration of our new "Diamond" center hole. Rotary part numbers 17222, 17223 17224, 17225 that will adapt to MTD's "S" shaped spindle shaft.

CASTER WHEEL ASSEMBLY

08 - 17108

REPLACES 422-0023-00
FITS ALL SPARTAN MODELS



TIRE SIZE
13 X 6.50 X 6



BLADE NUT -12 MM

10 - 15825

REPLACES JOHN DEERE M156416



HYDRO PUMP BELT FOR BAD BOY

12 - 17130

REPLACES BAD BOY 041-8000-00 ARAMID FIBER, LAMINATED RAW EDGE CONSTRUCTION ALL SPARTAN MODELS

FITS 2019 AND 2020 BAD BOY RENEGADE MACHINES, GAS AND DIESEL, 2020 - 2022 REVOLT WITH 36" DECK ONLY



ARIENS / GRAVELY BELT

12 - 17165

REPLACES BELT FOR OEM 07200028. WRAPPED BB, 130.0 EL.

FITS ARIENS MODELS ZOOM 2660 HD, MAX ZOOM 60" HD, MAX-ZOOM 60" SERIES, GRAVELY PRO MASTER 60", 890018, 890100, 890110



ARIENS / GRAVELY BELT

12 - 17166

REPLACES BELT FOR OEM 07200038. RAW EDGE COG, 63.0" EL.



SPINDLE PULLEY FOR HUSTLER



13 - 17136

REPLACES HUSTLER 603987
FITS 42" RAPTOR AND 42" DASH XD



13 - 17137

REPLACES HUSTLER 603988
FITS 52" RAPTOR MACHINES



13 - 17138

REPLACES HUSTLER 607504
FITS 36" TRIM STAR MACHINES



13 - 17139

REPLACES HUSTLER 607505
FITS 48" TRIM STAR MACHINES



13 - 17140

REPLACES HUSTLER 607506
FITS 54" TRIMSTAR MACHINES



13 - 17142

REPLACES HUSTLER 607889
FITS 42" RAPTOR X, XL AND XD

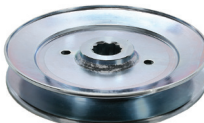

13 - 17143

REPLACES HUSTLER 607507,
TRIMSTAR 60"
FITS 60" TRIMSTAR MACHINES

HUSTLER RAPTOR PULLEY 54"

13 - 17178

REPLACES HUSTLER 604664
FITS RAPTOR SD, SDX, XDX,
X, XL, XD AND FLIPUP



HUSTLER RAPTOR PULLEY 48"

13 - 17179

REPLACES HUSTLER 604665
FITS RAPTOR SD, SDX, AND
FLIPUP



INLINE FUEL SHUT OFF 1/4" (6.4 MM)

20 - 16608

RUSTPROOF NICKEL-PLATED BRASS WITH A STURDY COMPACT DESIGN



1/4" BRASS FUEL LINE ELBOW

20 - 16609

90 DEGREE BRASS FUEL LINE ELBOW



FUEL LINE 1/4" X 3/8" RED

20 - 16610

10 FOOT ROLL, HELIX 1/4" X 3/8" POLYURETHANE FUEL LINE



EXCELON FUEL LINE 1/4" ID X 3/8" OD

20 - 17173

YELLOW LINE, (FOR KEROSENE, GASOLINE, OILS, CUTTING COMPOUNDS AND OTHER CHEMICALS)



ENGINE GASKET SET

23 - 10401

REPLACES B&S 299577

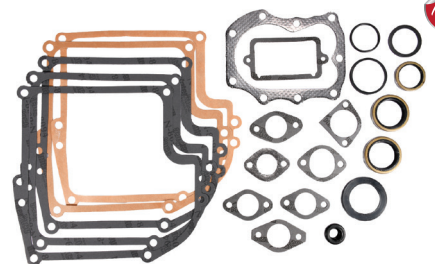

BUMP FEED TRIMMER HEAD (TREX-2000)

TWO OR FOUR STRING CONFIGURATION / STRING DIAMETERS FROM .080" TO .115"



27 - 17200

FITS ECHO, HONDA, HUSQVARNA, CUB CADET, HITACHI, REDMAX, SHINDAIWA AND MORE STRAIGHT SHAFT

27 - 17201

FITS STIHL STRAIGHT SHAFT TRIMMERS



DRUM PUMP

32 - 17146

TERA PUMP TRRA10 - ALUMINUM ROTARY ACTION DRUM PUMP

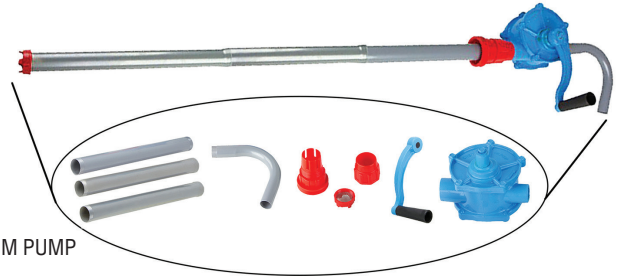

FITS ARIENS MODELS ZOOM 2260 HD, MAX ZOOM 2560, MAX ZOOM 60" SERIES, GRAVELY MODELS PRO MASTER 60", ZT 2760 HD, ZT 60 HD SERIES



TWO PACK GREASE TUBES

33 - 12646

18 X 7.00 - 8. 4 PLY TUBLESS MULTI-PURPOSE LITHIUM BASED GREASE



PANEL MOUNT TACHOMETER

33 - 17144

PANEL MOUNT TACHOMETER FOR BAD BOY FOR MOST MACHINES WITH CARBURETED ENGINES



IGNITION SWITCH FOR ARIENS

31 - 17134

REPLACES ARIENS 04331600, GRAVELY 04331600, KEY HAS RUBBER BOOT TO GUARD AGAINST WATER AND MOISTURE

FITS APEX AND APEX CE 48", 52" AND 60" CUT, GRAVELY PRO WALK 36", 48", 52", 60" CUT AND PRO TURN 148, 152 AND 160

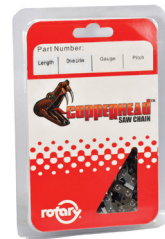

SAW CHAIN LOOP, 81 DL, .325 PITCH, .050" GAUGE, SEMI CHISEL, WITH BUMPER

34 - 7321081

REPLACES STIHL 23RM3-81 AND 3695-005-0081. SAW CHAIN LOOP, 81 DL, .325 PITCH, .050" GAUGE

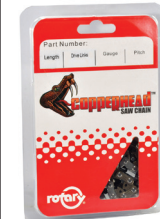

SAW CHAIN LOOP, 105 DL

34 - 7424105

REPLACES STIHL '33 RS 105 SAW CHAIN LOOP 105 DL; 3/8 STD PITCH; 0.50" G; FULL CHISEL W/O BUMPER



TIRE VALVE TOOL

32 - 16606

3-WAY VALVE FISHING

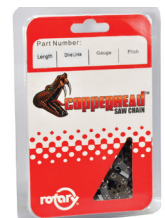

SAW CHAIN LOOP, 91 DL

34 - 7424091

REPLACES STIHL '33 RS 91 SAW CHAIN LOOP 91 DL; 3/8 STD PITCH; 0.50" G; FULL CHISEL W/O BUMPER

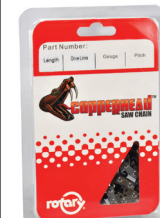

SAW CHAIN LOOP, 114 DL

34 - 7424114

REPLACES STIHL '33 RS 114 SAW CHAIN LOOP 114 DL; 3/8 STD PITCH; 0.50" G; FULL CHISEL W/O BUMPER



TIRE SPOONS

32 - 16607

SET OF 2 SPOONS

SPARKCHECK'R IGNITION TESTER



32 - 16740

ENGINE IGNITION ANALYZER



LAMINATED 18" GUIDE BAR WITH .325" PITCH SPROCKET TIP AND .050" GAUGE WIDTH. USES 68 DRIVE LINKS

35 - 9222318

